



Bear Mountain

✻ B O A T S ✻



Study Plans Catalogue

*Professional Canoe, Kayak & Small Boat Plans
for the Casual Builder*

Index

The Bear Mountain System	1
Good boats begin with good plans..	1
Building the boat	
that's right for you.....	2
Capacity and Stability Chart.....	3

Kayaks & Canoes

designed by Steve Killing

Venture 14'	4
Resolute 16'6".....	5
Endeavour 17'.....	6
True North 19'3".....	7
Reliance 20'8".....	8
Freedom 15'.....	9
Freedom 15'3" & 16'2".....	10
Freedom 17'.....	11
Freedom 17'9".....	12
Solo DayTripper 17'.....	13
Marathon 18'6".....	14
Chaa Creek Expedition 19'9".....	15
Cottage Cruiser 15'6".....	16

Prospector Type canoes

Bob's Special 15'.....	17
Ranger 15'.....	18
Prospector 16'.....	19
Nomad 17'.....	20

Pleasure Canoes

Huron Cruiser 15'9".....	21
Champlain 16'.....	22
Canadien 16'.....	23
J.G. Brown 16'.....	24
Rob Roy Solo 13'.....	25
Hiawatha 15'.....	26
RedBird 17'6".....	27

Small Boat Plans

Rice Lake Skiff.....	28
Stoney Lake Skiff.....	29
Ontario Whitehall.....	30

Other Products

Woodstrip Kits.....	31
Materials.....	31
Finger-Jointed Strips.....	31

The Bear Mountain system...

Building exquisite small craft using the Bear Mountain woodstrip/epoxy method is a series of simple steps that will be familiar to you or easy to learn. Our building method is ideal for the casual builder with basic woodworking skills.

Using Bear Mountain Plans and the step-by-step guidance from either of our books, **Canoecraft** or **KayakCraft**, professional results are possible even if this is your first boat project.

To build the hull, thin softwood planks are edge glued over a form constructed according to the full size plan. After planking and sanding, the outside and inside of the hull are covered with fiberglass cloth and epoxy resin. The hull is then trimmed, varnished and the appropriate fittings are installed to complete the boat.

The building technique is very simple and approachable as well as strong and beautiful. While it may not be the fastest or cheapest way to build a small boat, we think that the results can be the most rewarding.

Good boats begin with good plans...

The foundation of most successful boat building projects is a good plan. Since it takes the same time and materials to build a poor design as it does to build a good one, choose a plan you have confidence in, serves your needs and pleases your eye.

Our **traditional** designs are taken from historical craft that exhibit good characteristics and have stood the test of time. Traditional canoes that were designed for work and play will suit the eye of the traditionalist and respond to classic paddling techniques.

We are pleased to offer **contemporary** style canoes and kayaks designed by Steve Killing, one of Canada's foremost yacht designers. His designs incorporate many of the lessons he has learned about hull shape from paddling, sailing and rowing. He is also an artist, combining perfect balance of proportion with graceful, functional lines.

*Ted Moores and Joan Barrett
Peterborough, 2008*

Building the boat that's right for you...

We understand the importance of knowing what kind of boat you will be paddling on launch day. Steve Killing developed this unique formula to express stability in measurable terms, and capacity as the optimum load a boat can efficiently carry. This capacity and stability chart will help you choose wisely between our many designs.

Some manufacturers list capacity as the amount of weight that can be loaded into the boat with an unspecified amount of freeboard remaining – information which is of little use in making a safe intelligent decision. Others assume a wide hull is more stable than a narrow one, disregarding the fact that the maximum beam is only one of many factors that affect stability.

For those technical folks, our stability figures are measured at 15 degrees of heel and are related to the height at which the vertical line through the center of buoyancy intersects the hull centre line. For comparison purposes, we have chosen a value of 100 to be midrange, with higher values indicating more stability.

Keep these terms in mind...

Capacity – optimum safe load the boat can efficiently carry

Displacement – weight necessary to sink the boat to the design waterline

Weight to immerse – number of pounds necessary to sink the hull each additional inch past the design waterline

Consider the shape of the hull:

Traditional hull shapes are most often symmetrical (the bow is the same as the stern) which permits the boat to be paddled in either direction.

Asymmetrical hull shapes are most often found on modern craft with a finer front end and a slightly larger aft end which increases the over all speed of the boat and makes it easier to paddle.

While modern canoes may be more efficient, we would suggest that a more important decision for you is which style you like the look of. Our modern designs all have bows without re-curve and some people love that look while others prefer the traditional look.

Use our chart along with the description accompanying each design to assist you in choosing the plan that is right for you.

CAPACITY AND STABILITY CHART

Canoes





	Stability Factor	Optimum Capacity
Marathon 18/6	49	150-250
Rob Roy Solo 13	71*	110-250
J.G. Brown 16	74	280-390
Canadien 16	86	280-390
Hiawatha 15	88	150-390
Huron Cruiser 15/9	92	180-450
Champlain 16	92	280-450
Solo Day Tripper 17	92	150-250
Red Bird 17/6	92	280-510
Freedom 15/3 & 16/2	95	150-330
Cottage Cruising 15/6	97	150-450
Freedom 17	98	150-510
Bob's Special 15	100	150-450
Nomad 17	102	350-680
Prospector 16	103	350-540
Freedom 15	104	150-450
Ranger 15	104	150-450
Chaa Creek Expedition 19/9	105	430-820
Freedom 17/9	111	400-680

Kayaks

	Stability Factor	Optimum Capacity
Venture 14	72*	90-200
Endeavour 17	100	150-260
Resolute 16/6	121	130-290
Reliance 20/8	121	250-500
True North 19/3	124	300-460

Small Boats

Stoney Lake Skiff	141	180-600
Ontario Whitehall	168	160-780
Rice Lake Skiff	169	180-600

-  requires skill and experience (except the Rob Roy & Venture – see below)
-  requires skill but with experience will be comfortable
-  comfortable for most paddlers
-  very stable and comfortable for all paddlers

* The stability factor for the Rob Roy and the Venture are deceptive. Both boats are designed for single paddlers seated low in the boat so, even though the stability numbers are low both craft are comfortably stable.

Venture

14' Sport Kayak

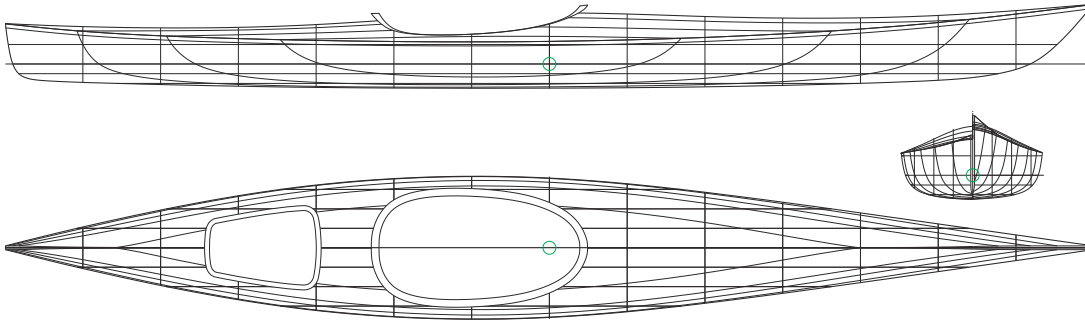

This sport kayak is suitable for small adults and children up to a weight of about 140 lbs. The rocker at the aft end has been straightened to aid in straight line paddling - so necessary on a small boat made for cruising. The bow is slightly more vertical than either the Resolute or the Endeavour to be more in scale with its size. The boat has a perky feel with a springier sheer line, compact length and the upright bow. The beam although less than the Endeavour 17 will give an apparent stability equally as good because of the lower centre of gravity of smaller paddlers. With the lowest low speed resistance of all the kayaks it will be a pleasure to paddle in calm bays or open lakes.

Specifications

- Length 14'
- Maximum beam 22"
- Beam waterline 20.5"
- Beam gunnel 22"
- Bow height 13"
- Centre depth 12"
- Draft 3.5"
- Displacement 200 lbs.
- Wetted surface 16.7 sq.ft.
- Weight to immerse 74 lb/ in
- Prismatic coefficient 0.557
- Weight 45 to 50 lbs
- Cockpit opening 31" x 16"
- Stability Factor 72
- Optimum capacity 90-200 lbs

© Designed by Steve Killing
Steve Killing Yacht Design Inc.

Resolute

16'6" Touring Kayak

Specifications

- Length 16'6"
- Maximum beam 25.5"
- Beam waterline 24"
- Beam gunnel 25.5"
- Bow height 13.5"
- Centre depth 7"
- Draft 3.5"
- Displacement 260 lbs.
- Wetted surface 22.2 sq. ft.
- Weight to immerse 102 lb/ in.
- Prismatic coefficient 0.569
- Weight 45 to 50 lbs
- Cockpit opening 30.5" x 18"
- Stability Factor 121
- Optimum capacity 130-250 lbs

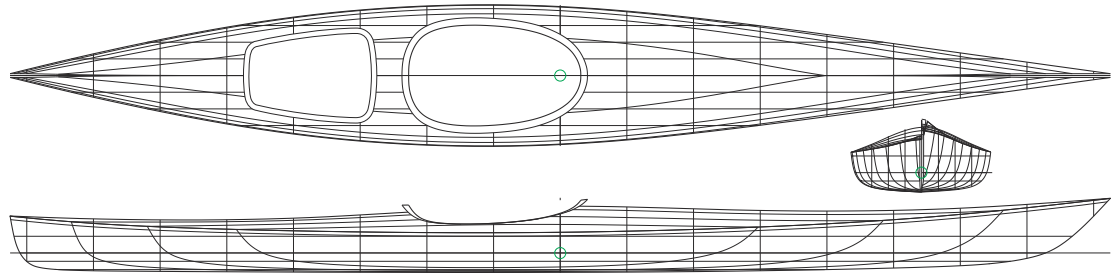

Developed in response to requests from heavier and wider paddlers who also wanted a shorter boat, this stable load carrier is excellent for the novice kayaker. It will inspire confidence and lead to a continuing enjoyment of the sport. Like the 14 footer, the rocker has been reduced aft to aid in tracking ability. The beam is ample at 25.4" and the cockpit has been widened to match. The hull is a very shallow vee, the flattest of the hulls shown here to permit the width for stability and yet maintain a moderate displacement. A maximum beam of 25.4" compared with the 17 footer at 23.5" is more stable and has good load capacity. Average load is 260 lbs. but it can handle up to 340 lbs. without a problem.

© Designed by Steve Killing
Steve Killing Yacht Design Inc.

Endeavour 17'

Touring Kayak

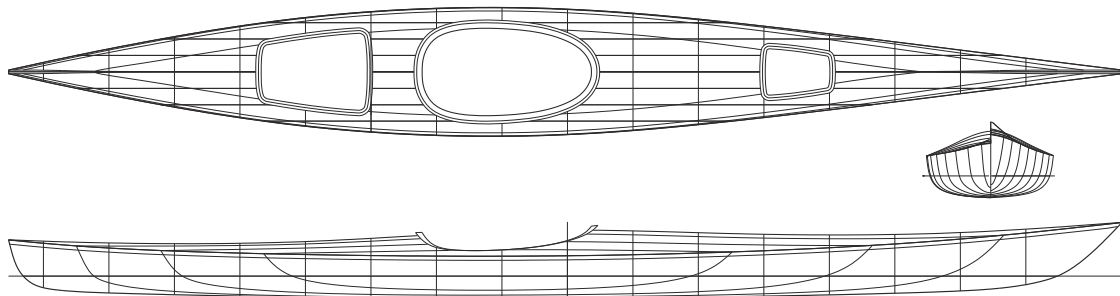

The beauty of this kayak will hit you when you first set up the station molds. It is sleek, graceful and a pleasure to paddle. Perfect for day trips or week long excursions, you will find the boat tracks well, goes fast and behaves itself in waves. Mike O'Brien, senior editor of **WoodenBoat Magazine** had this to say: "the sharply raked stem and well shaped forward sections will provide increasing buoyancy as the Endeavour punches into large waves. The fine run, and nearly vertical sternpost, will help ensure positive control when we are running off in a big sea (one of the scariest elements of sea kayaking). In all, this hull has a friendly and competent look to it."

Specifications

- Length 16'11"
- Maximum beam 23.5"
- Beam waterline 22"
- Beam gunnel 23.5"
- Bow height 14"
- Centre depth 7.5"
- Draft 4"
- Displacement 280 lbs.
- Wetted surface 21.8 sq. ft.
- Weight to immerse 97 lb/ in.
- Prismatic coefficient 0.561
- Weight 45 to 50 lbs
- Cockpit opening 31" x 15.5"
- Stability Factor 100
- Optimum capacity 150-260 lbs

© Designed by Steve Killing
Steve Killing Yacht Design Inc.

True North XPD

a high capacity modern solo kayak

Specifications

- Length 19'3"
- Maximum beam 25.5"
- Beam waterline 24"
- Beam gunnel 25.5"
- Bow height 15"
- Centre depth from sheer 9"
- Draft 4"
- Displacement 360 lbs.
- Wetted surface 26.8 sq. ft.
- Weight to immerse 120 lbs/ in
- Prismatic coefficient 0.563
- Weight 50-60 lbs
- Cockpit opening 33.5" x 18.5"
- Stability Factor 124
- Optimum capacity 300-460 lbs

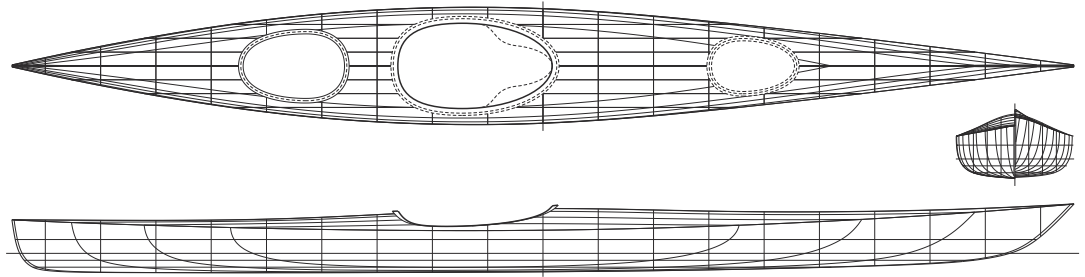

The True North XPD Expedition brings the thrilling performance and graceful styling of the Endeavour 17 to the big or tall paddler. The True North was inspired by Ron Frenette and friends at Canadian Canoes in Mississauga, Ontario. Ron and his keen group of builders needed a kayak with more capacity for the bigger than average paddler taking extended trips. The generous keyhole cockpit aids in getting in and out while providing effective knee support while paddling. Deck height has been increased by over an inch to accommodate big feet and allow room to move around and stretch during extended periods of paddling.

© Designed by Steve Killing
Steve Killing Yacht Design Inc.

Reliance

20'8" Tandem Kayak

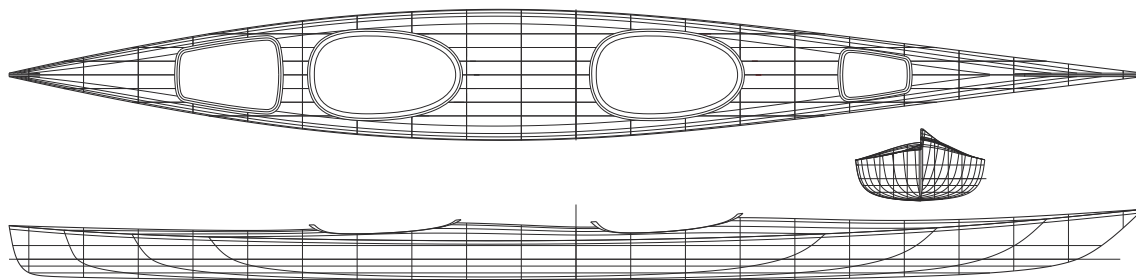

This boat has a comfortable feel to it. The length gives an incredibly calm unhurried impression even when the boat is moving at top speed. The beam of 28.5" provides room for cargo and gives a stability that makes kayaking in any weather comfortable. Moderate flare above the waterline will increase the stability as the boat heels. Two water tight compartments with access only by deck hatches provide enough flotation to keep the boat afloat in the event of a capsized.

Specifications

- Length 20'8"
- Maximum beam 28.5"
- Beam waterline 27"
- Beam gunnel 28.5"
- Bow height 15'8"
- Centre depth 12.9"
- Draft 4.8"
- Displacement 500 lbs.
- Wetted surface 32.8 sq.ft.
- Weight to immerse 145 lb/ in
- Prismatic coefficient 0.561
- Cockpit opening 31"x 17"
- Weight 50 to 60 lbs.
- Stability Factor 121
- Optimum capacity 250-600 lbs

© Designed by Steve Killing
Steve Killing Yacht Design Inc.

Freedom 15

Modern efficient pleasure canoe

Specifications

- Length 15'
- Maximum beam 35.25"
- Beam waterline 33.4"
- Beam gunnel 34.3"
- Bow height 19.25"
- Centre depth 13.1"
- Draft 4.46"
- Displacement 400 lbs.
- Wetted surface 28.0 sq.ft.
- Weight to immerse 133 lb/ in
- Prismatic coefficient 0.566
- Weight 45 to 50 lbs.
- Keel-less or shoe keel
- Stability factor 104
- Optimum capacity 150-450 lbs

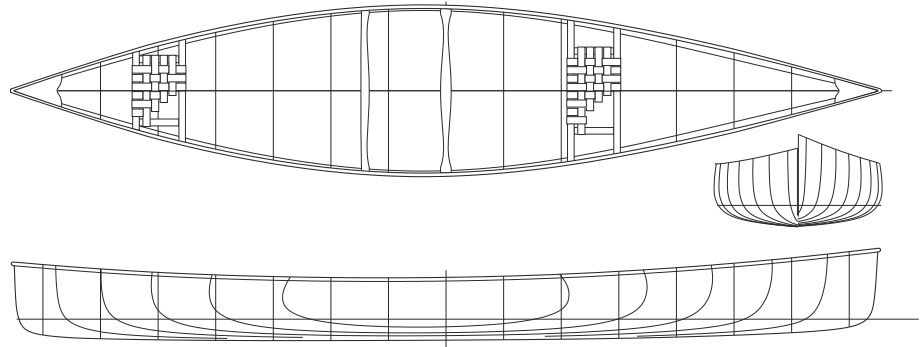

Like its sisterships, the Freedom 15 features an asymmetrical hull with a fine bow and slightly fuller stern. The mid section has mild tumblehome for comfortable solo paddling and good structural rigidity. A small canoe has an easier time turning corners and needs some design features to aid with straight-line tracking. To this end, the Freedom 15 has less rocker and deeper aft sections for effortless steering. The 35" beam gives it a stability factor of 104 which means it will give confidence to those on board, and yet be a pleasure to paddle. We see it on lakes, rivers, and portages being used for camping, day trips, fishing and just playing around.

© Designed by Steve Killing
Steve Killing Yacht Design Inc.

Freedom 15/3 & 16/2

Modern efficient pleasure canoe

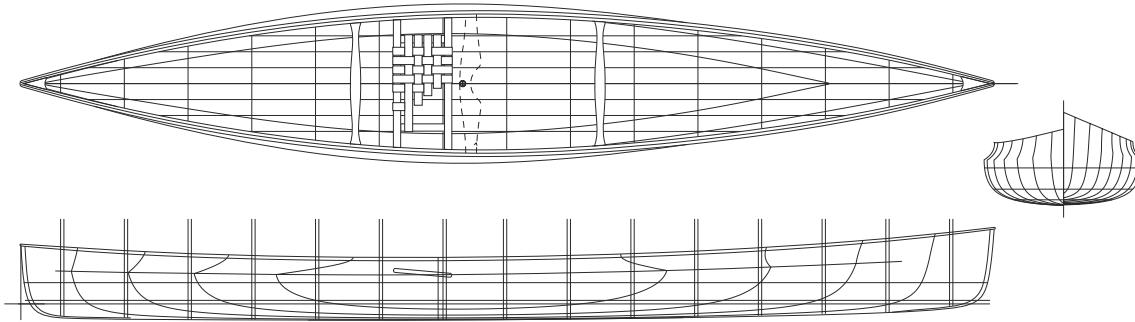

The Freedom Solo is the result of a unique project initiated in the spring of 2006. As an experiment, Steve decided to poll the opinions of paddlers and builders as he designed the boat. Predictably, opinions varied, but did so about a common theme. The boat, they felt should be short, light, medium tracking and therefore medium manoeuvrability, low freeboard, narrow, and offered in two lengths. The unique tumblehome chine was accepted (by most) as a good solution, attractive, and relatively easy to build. The result is a fine solo tripping canoe which will require at least intermediate paddling skills due to its lower-than-average stability.

Specifications

- Length 15-3" or 16'-2"
- Maximum beam 30.0"
- Beam waterline 26.5"
- Beam gunnel 26.2"
- Bow height 17.5"
- Centre depth 12"
- Draft 3.0"
- Displacement 220 lbs.
- Wetted surface 22.0 sq.ft.
- Weight to immerse 106 lb/in
- Prismatic coefficient 0.564
- Weight 45 to 50 lbs
- Stability factor 95
- Optimum capacity
 - 15'3" version 150-290 lbs
 - 16'2" version 180-330 lbs

© Designed by Steve Killing
Steve Killing Yacht Design Inc.

Freedom 17

Modern efficient tripping canoe

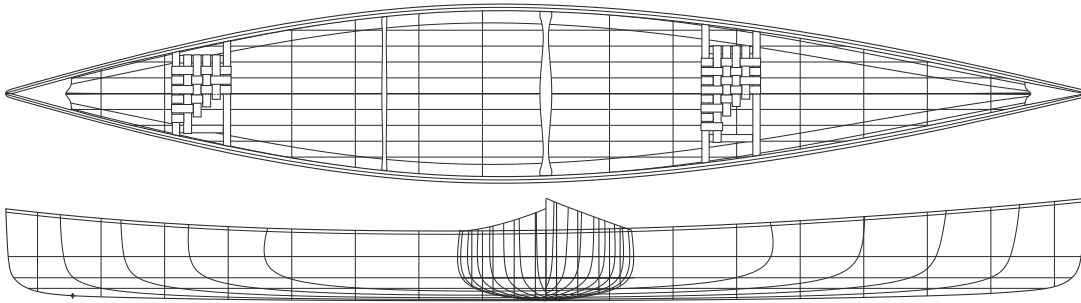

The Freedom 17 features an asymmetrical hull with a slim bow, a maximum beam just aft of the middle and filled out stern sections to reduce the resistance. The gently rockered profile lets the boat turn with ease. Because of the slight tumblehome this canoe is a wonderful solo boat, but most of the time it can be found heading off on canoe trips with two avid canoeists on board. A fast responsive tripping canoe that's also easy to build.

Specifications

- Length 17'
- Maximum beam 33.4"
- Beam waterline 31.75"
- Beam gunnel 32.5"
- Bow height 19.25"
- Centre depth 13.25"
- Draft 4.25"
- Displacement 420 lbs.
- Wetted surface 30.15 sq.ft.
- Weight to immerse 143.8 lb/ in
- Prismatic coefficient 0.567
- Weight 45 to 55 lbs
- Stability factor 98
- Optimum capacity 150-510 lbs

© Designed by Steve Killing
Steve Killing Yacht Design Inc.

Freedom 17/9

Modern efficient tripping canoe

Specifications

- Length 17' 9"
- Maximum beam 35.5"
- Beam waterline 32.5"
- Beam gunnel 35"
- Bow height 21"
- Centre depth 14"
- Draft 4.25"
- Displacement 420 lbs.
- Wetted surface 31.5 sq.ft.
- Weight to immerse 150 lb/ in
- Prismatic coefficient 0.553
- Weight 55 to 60 lbs.
- Stability factor 111
- Optimum capacity 400-680 lbs

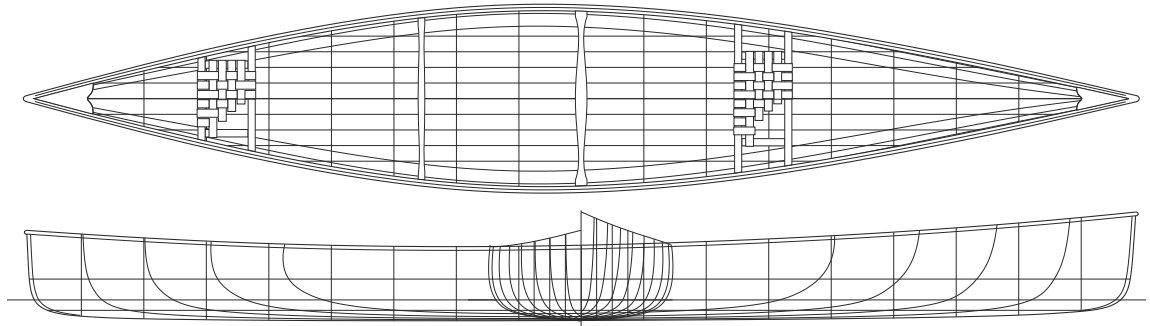

Steve Killing designed this big Freedom canoe for those who loved the feel of the 17, but simply needed to carry a bigger load. Whether it's more people, bigger people or more packs for an extended wilderness trip, they will fit. The length, beam and freeboard have been increased with only subtle changes to the hull shape. The resulting stability is high. With slightly more rocker than many modern canoes, the Freedom series has gained back the turning ability found in traditional canoe shapes, without sacrificing the speed of the modern hull.

"We haven't forgotten that canoes should look good and this is one of the prettiest canoes you'll find".

© Designed by Steve Killing
Steve Killing Yacht Design Inc.

17' Solo Day-Tripper

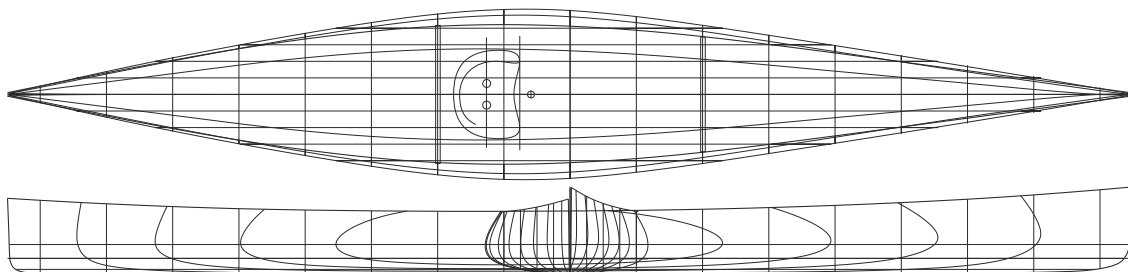

For those beautiful days out for lunch on the river or an evening on the lake by yourself, this is the boat. This asymmetrical design (the forward sections are finer than those aft) can be paddled from a tractor style seat while switching sides every eight strokes or from a traditional seat with the boat heeled over. Over two and a half inches of tumblehome either side bring the gunnels in for comfortable paddling.

Designers comments: "The large tumblehome was designed into this boat for ease of paddling, but what it does to the appearance of the boat is dramatic. The narrow gunnel width emphasises the slim lines and the high section curvature near the waterline looks dramatic. And I think you will find this boat paddles even better than it looks."

Specifications

- Length 17'
- Maximum beam 30.7"
- Beam waterline 28.5"
- Beam gunnel 25"
- Bow height 16"
- Centre depth 11.25"
- Stern height 14"
- Draft 3"
- Displacement 244 lbs.
- Wetted surface 25.2 sq.ft.
- Weight to immerse 123 lb/ in
- Weight 45 to 55 lbs.
- Stability factor 92
- Optimum capacity 150-250 lbs

© Designed by Steve Killing
Steve Killing Yacht Design Inc.

18'6" Marathon

Specifications

- Length 18'5.5"
- Maximum beam 32.2"
- Beam waterline 27.7"
- Bow height 15.5"
- Stern height 11.75"
- Centre depth 11.75"
- Draft 3.09"
- Freeboard 12.75"
- Displacement 230 lbs.
- Wetted surface 22.76 sq.ft.
- Weight to immerse 101 lb/ in
- Prismatic coefficient 0.514
- Weight 28+ lbs
- Stability factor 49
- Optimum capacity 150-250 lbs

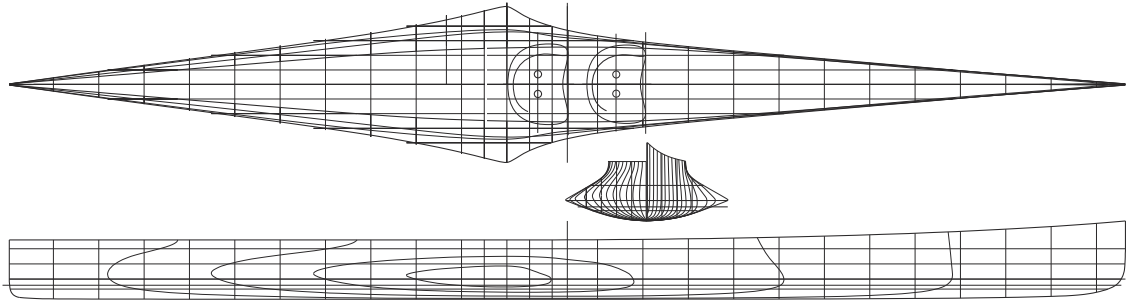

This racing C1 is designed to the marathon racing rules and hence the unusual shape. The wings just aft of the middle of the boat are now commonplace on most C1 designs and are there to meet the beam requirement of the rule. Forward and aft of that point the hull narrows quickly to reduce weight, wetted surface and beam. The narrow beam just forward of the wings provides an ideal location to finish the paddling stroke without having to reach over a wide gunnel.

This construction project is for the advanced builder as the shapes to be planked around the wing are challenging.

Chaa Creek

Expedition Canoe

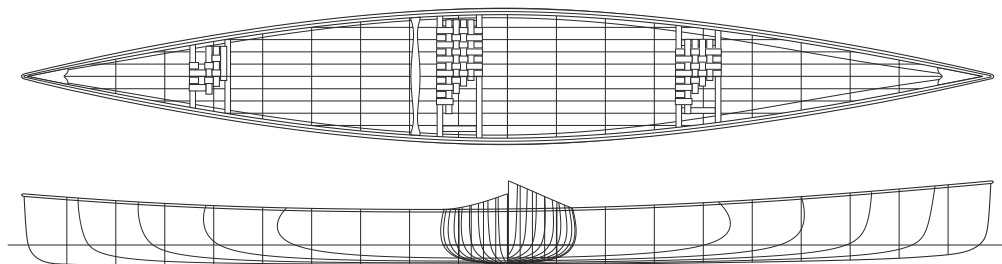

The Chaa Creek Expedition is a high volume, high performance boat first built on the banks of the Macal River in 2000 for use in Ruta Maya Belize River Challenge – a four day race which takes place every March in this central American country. Steve Killing designed this hull to go far and fast while carrying a good load. It has proven to be a good wilderness boat as well as a great family recreational canoe.

The relatively narrow beam makes for an efficient hull shape. It is still very comfortable with a stability factor of 105.

For more information on La Ruta Maya race: www.bearmountainboats.com/news_03.htm

Specifications

- Length 19.9'
- Maximum beam 33.4"
- Beam waterline 32"
- Beam gunnel 31.75"
- Bow height 20.6"
- Centre depth 13.5"
- Draft 5"
- Displacement 580 lbs.
- Wetted surface 37.1 sq.ft.
- Weight to immerse 170 lb/ in
- Prismatic coefficient 0.570
- Weight 60 lbs
- Stability factor 105
- Optimum capacity 430-820 lbs

© Designed by Steve Killing
Steve Killing Yacht Design

15"6" Cottage Cruising Canoe

Specifications

- Length 15' 6"
- Maximum beam 35"
- Beam waterline 31.75"
- Beam gunnel 33"
- Bow height 20"
- Centre depth 13.5"
- Draft 4"
- Displacement 337 lbs.
- Wetted surface 12.8 sq.ft.
- Weight to immerse 58 lb/ in
- Prismatic coefficient 0.553
- Weight 55 to 60 lbs.
- Stability factor 97
- Optimum capacity 150-450 lbs

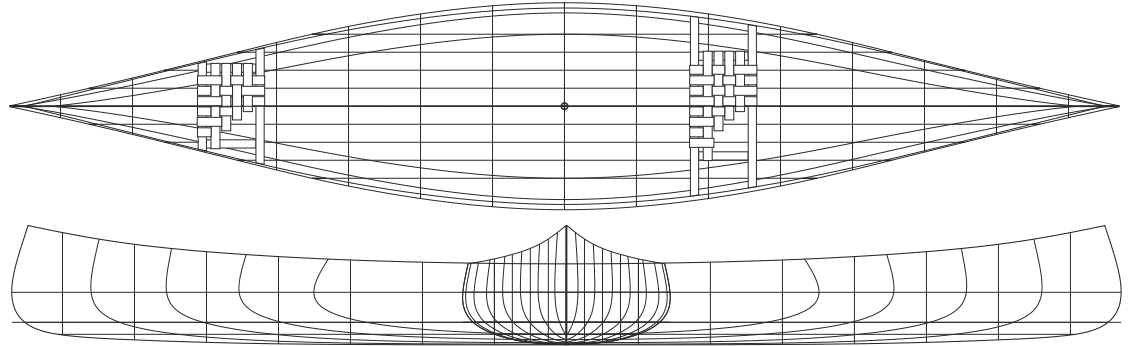

The Canadian Canoe Company just north of Toronto spearheaded this project in 1997. They love traditional boats but wanted a midsize hull that had a little more capacity than the 15 footers. This new design quite obviously borrows some of its heritage from the Prospector series but is graced with a little more tumblehome in the hull sides and less curvature in the sheer. We think it is even better looking than the boats you remember as a kid.

Don't let the cottage reference fool you, this boat is happy playing near the beach, on portages or off on a two week canoe trip. It planks up beautifully and will make you look like a professional.

© Designed by Steve Killing
Steve Killing Yacht Design Inc.

15' Bob's Special

Traditional Work & Pleasure Canoe

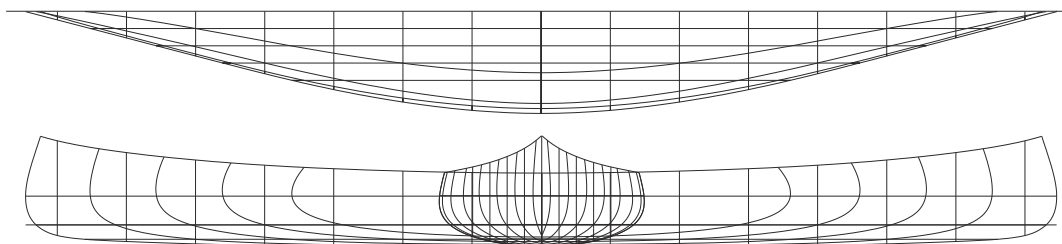

"The Chestnut 50-lb. Special has been designed to meet a certain demand for an extremely light weight canoe of good carrying capacity and has proved very popular. Owing to its width and flat bottom it is very steady and the ends are low, making it easy to portage through the brush." ...from the 1950 Chestnut Canoe Co. catalogue.

One of their Chestnut's better known models, it is favoured by fishermen and solo trippers. The moderate rocker and soft bilges make this a great canoe for traditional style solo paddling.

In order to adapt to strip planking, some modifications to the original lines have been made. A shoe keel was recommended on the original canoe because of the light weight ribs and planking. Since they are not saying it is for directional stability, we can assume that the keel is optional.

Specifications

- Length 15'
- Maximum beam 36"
- Beam waterline 32.5"
- Beam gunnel 34.5"
- Bow height 19"
- Centre depth 12.5"
- Draft 4"
- Displacement 325 lbs.
- Wetted surface 25 sq.ft.
- Weight to immerse 125 lb/ in
- Weight 45 to 55 lbs.
- Stability factor 100
- Optimum capacity 150-450 lbs

© Designed by Steve Killing
Steve Killing Yacht Design Inc.

15' Ranger

Traditional Pleasure Canoe

Specifications

- Length 15'
- Maximum beam 35.2"
- Beam waterline 33.7"
- Beam gunnel 33.5"
- Bow height 22"
- Centre Depth 13.5"
- Draft 4"
- Displacement 375 lbs.
- Wetted surface 26.8 sq.ft.
- Weight to immerse 132 lb/ in
- Prismatic coefficient 0.557
- Keel-less or shoe keel
- Weight 45 to 55 lbs.
- Stability factor 104
- Optimum capacity 150-450 lbs

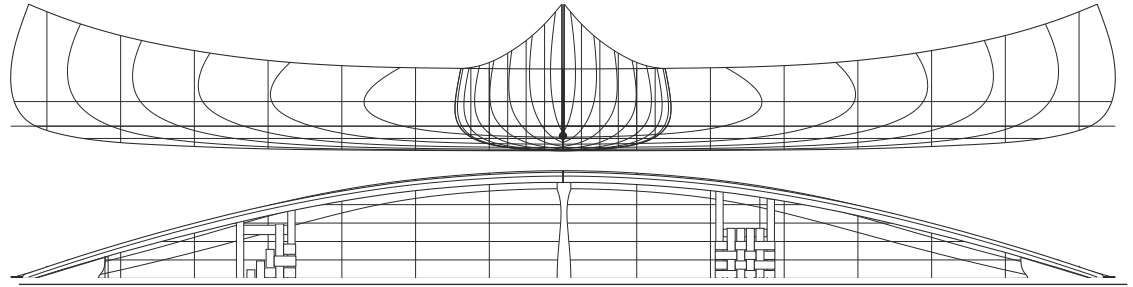

The **Prospector** models built by the Chestnut Canoe Company were made in lengths from 12 to 18 ft. filling a need for a canoe with greater carrying capacity than the Pleasure and Cruiser models but not as large as the Freight canoes.

This model, the 15' 'Ranger' is a sweet shape and Ron Frenette of Canadian Canoes decided we should have it in our catalogue. It has the same end shape and highly rockered hull of our 16' Prospector. With a flattened shallow arch bottom and full ends, the Ranger is stable, strong and a good load carrier. If you are looking for a canoe in the fifteen foot range with some history and good all round paddling characteristics, this might be the one you are looking for.

© The Bear Mountain Boat Shop 1993
 Lines taken by Ted Moores, 1993
 Redrawn by Steve Killing, 1999

16' Prospector

Traditional Work & Pleasure Canoe

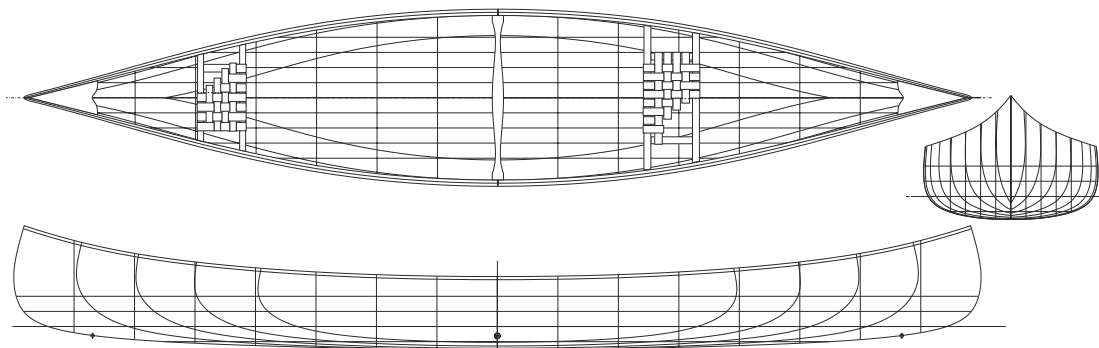

The Chestnut Canoe Company built this "workhorse of the North" to meet the specific needs of the prospector - good maneuverability through whitewater and wilderness, with capacity to carry substantial loads. The 16' Prospector features a flattened, shallow arch hull with its fullness carried into the bow and stern, good depth amidships to maintain freeboard and deepened ends to keep paddlers and gear dry. The rockered keel-line makes it very maneuverable in whitewater. This was the favoured canoe of the late Bill Mason, Canada's premier paddler...*"it is amazing that such a large-volume tripping canoe can also be so beautiful to paddle solo in the leaned position - canoe ballet, as I call it. It is the ideal all-round canoe."*

Specifications

- Length 16'
- Maximum beam 35"
- Beam waterline 33.25"
- Beam gunnel 34.4"
- Bow height 19.25"
- Centre depth 13.25"
- Draft 4.75"
- Displacement 420 lbs.
- Wetted surface 27.2 S.F.
- Weight to immerse 120lb/ in
- Prismatic coefficient 0.510
- Weight 45 to 55 lbs.
- Stability factor 103
- Optimum capacity 350-540 lbs

© The Bear Mountain Boat Shop 1993
Lines take by Ted Moores, 1981
Drawn by Ted Moores, 1993
Redrawn by Steve Killing, 1999

Nomad 17

Prospector Type Traditional Recreational Canoe

Specifications

- Length 17'
- Maximum beam 35"
- Beam w/1 32.6"
- Beam gunnel 34"
- Bow height 25"
- Centre Depth 14.5"
- Draft 4.5"
- Displacement 416 lbs.
- Wetted surface 28.6 sq.ft.
- Weight to immerse 169 lb/ in
- Mom to trim 600 in-lb/ in
- Prismatic coefficient 0.532
- Weight 55 to 65 lbs.
- Stability factor 102
- Optimum capacity 350-680lbs

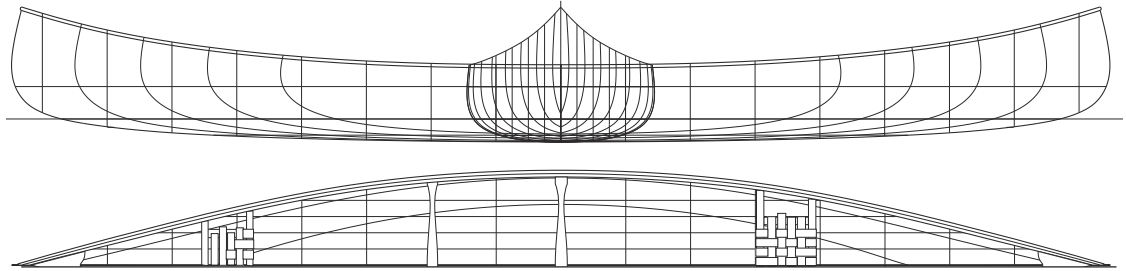

Recognising the popularity of the classic 16' Chestnut Prospector 'Fort', Canadian Canoes commissioned Ted Moores to design a 17' tripping canoe which would be a kindred spirit to the 'Fort'. The mid section and profile are similar to our 16' Prospector but with much of the hollow in the waterlines removed. This uninterrupted direction of water flow allows the canoe to move through the water with the least amount of resistance. It adds some fullness (lift) to the hull below the waterline as well as being a very easy shape to plank.

A new wood canvas form was constructed in March of 1994 from the Moores' design and a number of Wilderness Nomad's are now in service. The design is so successful that Ron Frenette decided we should make this craft available using the Bear Mountain wood/ epoxy strip building technique. The Nomad-S is long, sleek, easy to plank and easier to paddle.

Designed for Ron Frenette, Canadian Canoes Ltd. by Ted Moores, Feb. 1994
© The Bear Mountain Boat Shop 1995

15'9" Huron Cruiser

Traditional Pleasure Canoe

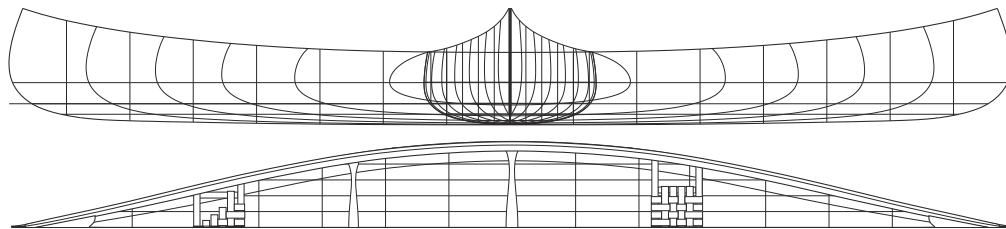

The lines for this canoe were taken from an original 'Huron' built in cedar/ canvas by the Peterborough Canoe Company. It was a second grade model in a series of Cruiser canoes that measured from 16'x33" to 18'x37". *"They have good carrying capacity while retaining a light draft, and are an easy paddling craft that can be handled well in rough or swift waters. The gunwale line is straighter in these models and is lowered at bow and stem, thus offering less wind resistance. The rounded bottom shape may reduce carrying capacity but the paddler may expect a quick and responsive craft."* ...from the 1929 Peterborough Canoe Co. catalogue.

Two types of optional keels were offered; the shoe keel (1/ 2" thick x 1 3/ 4" wide) for added protection or a lake keel (7/ 8" thick x 3/ 4" wide tapered to 3/ 8") for a small increase in directional stability.

Specifications

- Length 15'9"
- Maximum beam 32.5"
- Beam waterline 30.25"
- Beam gunnel 31"
- Bow height 22"
- Centre Depth 13.5"
- Draft 4"
- Displacement 335 lbs.
- Wetted surface 25.5 sq.ft.
- Weight to immerse 121 lb/ in.
- Prismatic coefficient 0.543
- Weight 45 to 55 lbs.
- Stability factor 92
- Optimum capacity 280-450 lbs

© Steve Killing Yacht Design, 1997
Lines taken & drawn by Steve Killing
for Ron Frenette, Canadian Canoes Ltd.

16' Champlain Traditional Recreational Canoe

Specifications

- Length 16'
- Maximum beam 32.5"
- Beam waterline 29.5"
- Beam gunnel 31.5"
- Bow height 26"
- Centre Depth 13.5"
- Draft 4"
- Displacement 325 lbs.
- Wetted surface 24.5 sq.ft.
- Weight to immerse 94 lb/ in
- Prismatic coefficient 0.557
- Keel-less or shoe keel
- Weight 45 to 55 lbs.
- Stability factor 92
- Optimum capacity 280-450 lbs

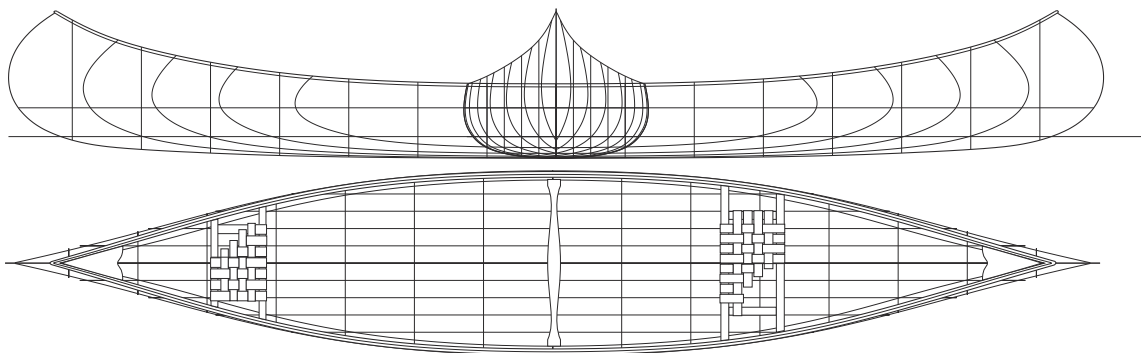

The Champlain High-ender, built by the Peterborough Canoe Company, was one of their most popular designs. Originally built in cedar/ canvas, it appeared in their final catalogue of 1961. The Champlain Low-ender, with less height in the ends, was built on the same mold.

A good traditional style general purpose recreational canoe. Features a moderate displacement, soft bilge and moderate rocker - paddles well in the 'heeled over' position. Ideal for recreational paddling (solo or tandem) and light tripping.

© The Bear Mountain Boat Shop 1993
Lines taken by Ted Moores, 1993
Redrawn by Steve Killing, 1999

16' Canadien 'The Cottager's Canoe'

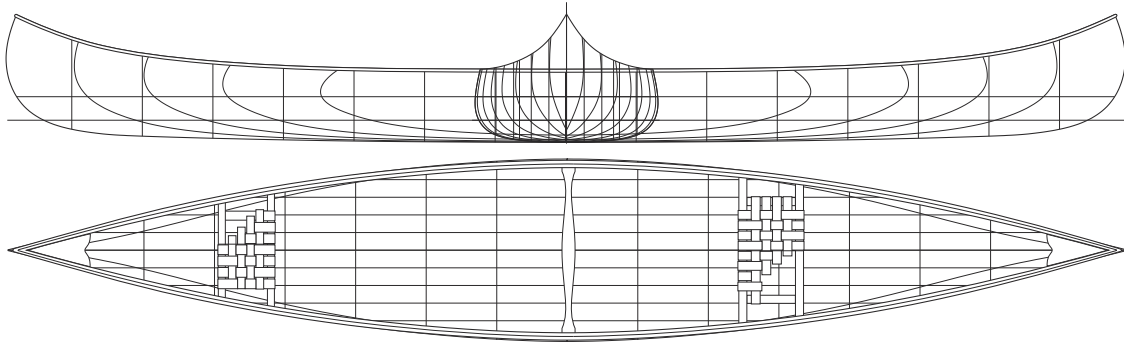

A 'Peterborough' canoe often referred to any open canoe, but this design comes from the company that made the town's name famous around the world. A direct descendant of the first "planked dugout" created 140 years ago by John Stephenson, it is thought to be the 'Canadien' model built in the original cedar strip technique. Its narrow beam and shallow arch hull make it ideal for general-purpose paddling and light tripping. Keeled, with a slightly rockered keel-line, it is responsive and easy to paddle. This favourite of the lake district has justifiably been dubbed 'the cottager's canoe'.

Specifications

- Length 16'
- Maximum beam 31.5"
- Beam waterline 30.3"
- Beam gunnel 30"
- Bow height 22"
- Centre depth 12.5"
- Draft 4"
- Displacement 350 lbs.
- Wetted surface 25.2 S.F.
- Weight to immerse 94 lb/ in
- Prismatic coefficient 0.525
- Weight 45 to 55 lbs.
- Stability factor 86
- Optimum capacity 280-390 lbs

© The Bear Mountain Boat Shop 1993
Lines take by Ted Moores, 1981
Drawn by Ted Moores, 1993
Redrawn by Steve Killing, 1999

J.G. Brown 16' Traditional Recreational Canoe

Specifications

- Length 16'
- Maximum beam 30.5"
- Beam water/line 27.5"
- Beam gunnel 29.5"
- Bow height 22"
- Centre depth 12"
- Draft 4"
- Displacement 300 lbs.
- Wetted surface 23.7 sq.ft.
- Weight to immerse 91 lb/ in
- Prismatic coefficient 0.537
- Weight 45 to 50 lbs.
- Stability factor 74
- Optimum capacity 280-390 lbs

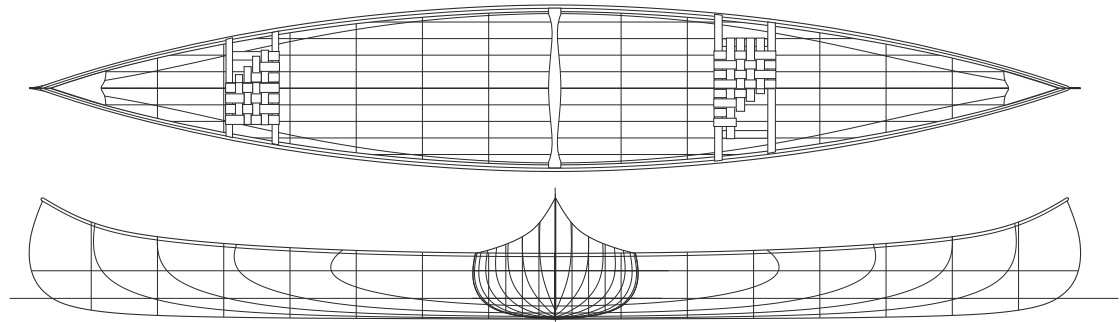

The inspiration for this design was built about 1900 by the J.G. Brown Mfg. Co., Lakefield, Ontario. 'Lorna' has been paddled since 1912 by the MacLennan family on Baptiste Lake. Original lines were taken in 1988 by Ted Moores and refaired by Steve Killing in 1999 with little alteration to the original shape. 'Lorna' is a good example of the highly developed 'Canadian Style' recreational canoe. This design is a fine balance of all the features desirable in a fast traditional recreational canoe. It has some characteristics in common with the Peterborough Canadien - it is narrow, fast and a pleasure to paddle.

© The Bear Mountain Boat Shop 1993
Lines take by Ted Moores, 1988
Drawn by Ted Moores, Aug. 1993
Redrawn by Steve Killing 1999

13' Rob Roy Double Paddle Canoe

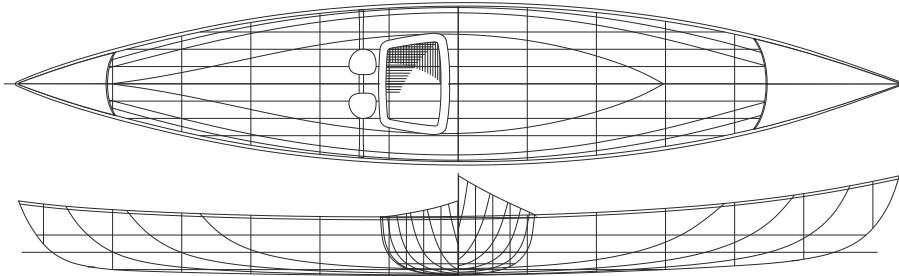

Truly the poor mans yacht, the origin of the Rob Roy goes back to England and the mid 1800's. John MacGregor, after seeing our native birch bark canoes and the Eskimo kayak, designed his idea of an efficient cruising canoe, calling it the Rob Roy. Typical of this type of solo canoe were: length 12' to 15', propelled with a double blade paddle from a sitting position and often rigged for sail. Early American canoe builders like J. Henry Rushton & W.P. Stephens were influenced by this style. Until the early 1900's, American recreational canoeing was dominated by the double paddle canoe.

This hull design has been built in many versions, from a simple light weight fast cruising canoe, to a full decked version of bookmatched walnut veneer, with sliding seat, foot rest, floorboards and hand rubbed varnish.

Specifications

- Length 12' 10.5"
- Maximum beam 27"
- Beam waterline 24.5"
- Beam gunnel 27"
- Bow height 17"
- Centre depth 10.2"
- Draft 4"
- Displacement 210 lbs.
- Wetted surface 16.6 sq.ft.
- Weight to immerse 79 lb/ in
- Prismatic coefficient 0.535
- Weight 25 to 40 lbs.
- Stability factor 71
- Optimum capacity 110-250 lbs

© The Bear Mountain Boat Shop 1993
 Designed by Ted Moores 1992
 Redrawn by Steve Killing 1999

15' Hiawatha

Specifications

- Length 15'
- Maximum beam 33.5"
- Beam waterline 31"
- Beam gunnel 33.5"
- Bow height 21.5"
- Centre depth 12.25"
- Draft 4.25"
- Displacement 320 lbs.
- Wetted surface 24.2 sq.ft.
- Weight to immerse 115 lb/ in
- Prismatic coefficient 0.525
- Weight 40 to 50 lbs.
- Keel-less or shoe keel
- Stability factor 88
- Optimum capacity 150-390 lbs

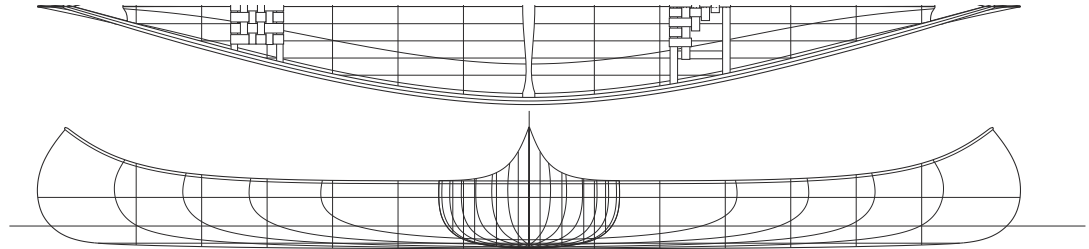

This traditional looking Bear Mountain design has a sheer-line and bow profile reminiscent of the early 'Canadian' style canoe. Below the waterline, the hull is a more up-to-date shape for paddling efficiency. The hull is a shallow arch with a moderately flat keel-line that flows into a shallow vee to become a fine deep vee at the bow for directional stability, speed and maneuverability. The vee is carried as far back as possible, acting as a keel, it contributes to directional stability without sacrificing maneuverability.

The Hiawatha is a general purpose recreational canoe of light displacement, designed in the tradition of contemporary American cruisers, achieving its optimum waterline shape when paddled level, rather than heeled over. A good solo canoe, it is also very fast and responsive with a double blade paddle.

© The Bear Mountain Boat Shop 1993
 Designed by Ted Moores 1986
 Redrawn by Steve Killing, 1999

Red Bird 17'6"

Fast tripping canoe

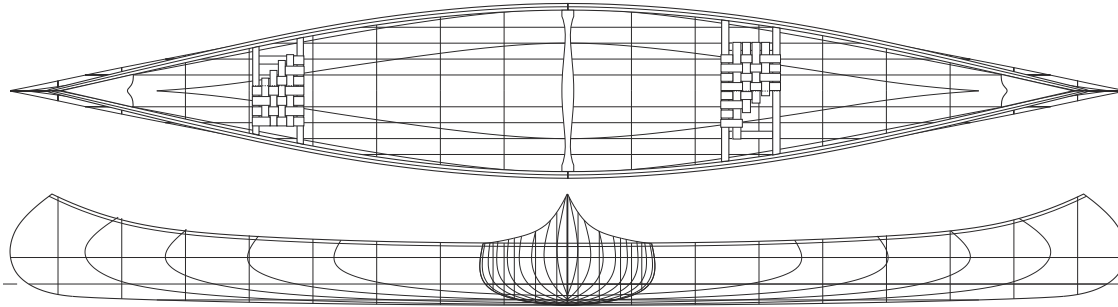

This Bear Mountain design is an efficient wilderness canoe that has proven exceptionally seaworthy, even in heavy seas around the Magdalen Islands in the Gulf of St. Lawrence and the North Sea. Its keeless shallow-arch hull with moderate rocker combines with a long waterline and fine entry to make it a fast responsive boat. The bow and stern profile are reminiscent of the Long Nose Ojibwa Rice Harvesting canoe. The sides have a moderate tumblehome for lateral strength and to allow outwales wide enough to turn aside waves and spray.

Specifications

- Length 17' 7.5"
- Maximum beam 33.5"
- Beam waterline 31.6"
- Beam gunnel 32.25"
- Bow height 21.25"
- Centre Depth 12"
- Draft 4"
- Displacement 370 lbs.
- Wetted surface 27.0 sq. ft.
- Weight to immerse 128 lb/ in
- Prismatic coefficient 0.496
- Weight 50 to 60 lbs.
- Keel-less or shoe keel
- Stability factor 92
- Optimum capacity 280-510lbs

© The Bear Mountain Boat Shop 1993
 Designed by Ted Moores 1981
 Redrawn by Steve Killing, 1999

Rice Lake

Traditional outboard skiff

Specifications

- Length 13'9"
- Maximum beam 48"
- Beam waterline 38"
- Beam gunnel 48"
- Bow height 19"
- Centre depth 16"
- Draft 4.8"
- Displacement 400 lbs.
- Wetted surface 30.7 sq.ft.
- Weight to immerse 154 lb/ in
- Prismatic coefficient 0.587
- Weight 70-90 lbs.
- Stability Factor 169
- Capacity 180-600 lbs.

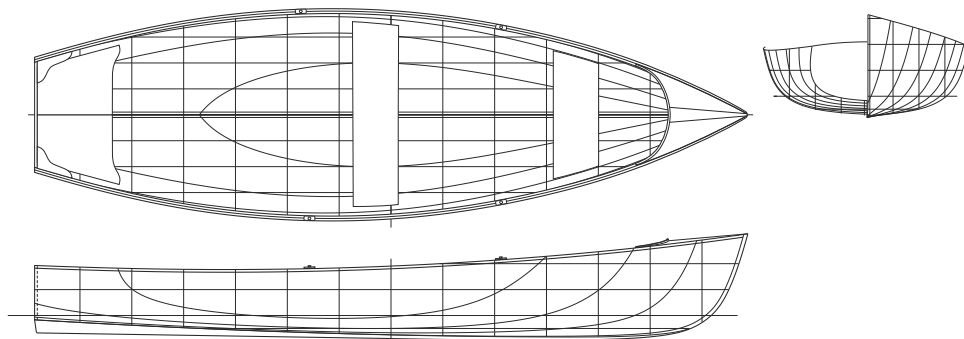

This sweet little skiff was built by the Rice Lake Boat Works during the transition from muscle power to the outboard. Sure to be a very useful boat at the cottage for fishing, rowing or just knocking about. It is one of the most stable boats we offer and will row well with up to three adults on board or a whole fleet of youngsters. A small outboard or electric motor will efficiently propel the boat for trolling, bird watching or just getting home a little faster. The lines were re-faired by Steve Killing keeping the character of the sheer, body sections and distinctive transom stern. Maximum engine: electric outboard 50lbs thrust or 5 HP gasoline.

Lines recorded by Ted Moores, 1992
© Drawn by Steve Killing

Stoney Lake

Peterborough style double ended rowing skiff

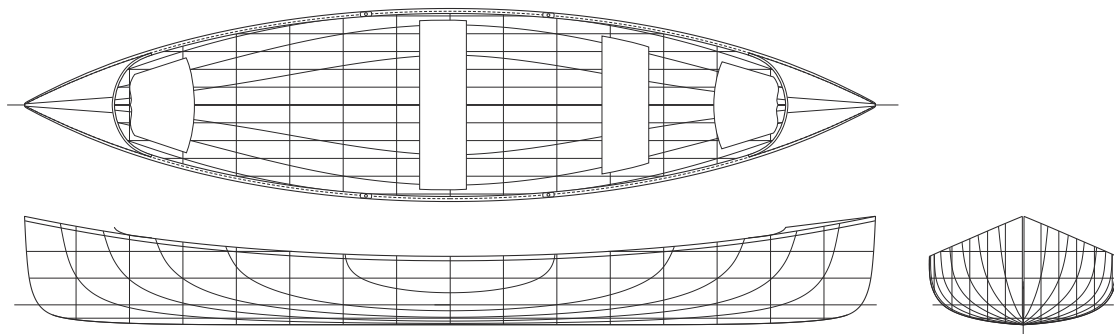

Used by several generations of cottagers for transportation around Stoney Lake, this double ended rowing skiff became known as a regatta winner. Thought to have been built by the Brown Boat Company, Lakefield, Ontario, the style is typical of the elegant cedar strip double ended skiffs built by several Peterborough area builders. Steve Killing has re-faired the hull and added slightly more volume to the ends to make rowing at moderate and high speeds more efficient. With two rowing positions, it is a versatile craft to enjoy alone or with your favourite partner out for a little fishing or an evening of conversation.

Specifications

- Length 16'
- Maximum beam 42"
- Beam waterline 36"
- Beam gunnel 42"
- Bow height 20"
- Centre depth 15.5"
- Draft 4.4"
- Displacement 400 lbs.
- Wetted surface 29.8n sq.ft.
- Weight to immerse 143 lbs/ in
- Prismatic coefficient 0.520
- Weight 60-70 lbs.
- Stability factor 141
- Capacity 180-600 lbs.

© Drawn by Steve Killing
Steve Killing Yacht Design Inc.

Ontario Whitehall

A modern version of an East Coast classic

Specifications

- Length 15' 11.5 "
- Maximum Beam 47"
- Displacement 400 lbs
- Bow height 20"
- Centre depth 15"
- Wt to immerse 147 lb/ in
- Optimum capacity 160-780 lbs
- Stability factor 168

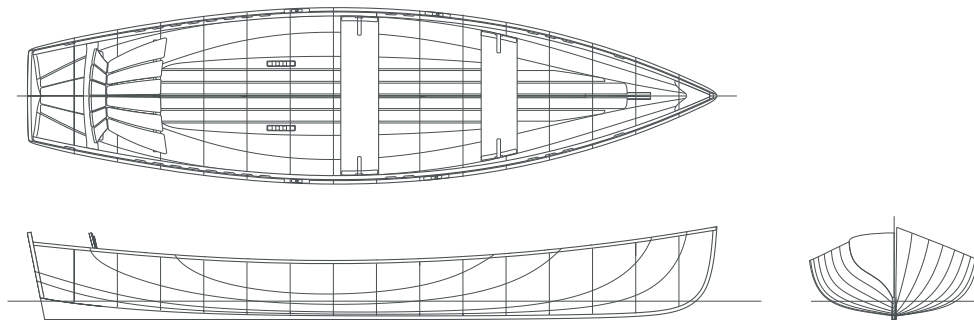

The Ontario Whitehall is a modern interpretation of a decidedly classic rowing boat. Whitehalls were originally designed for use as harbour boats in ports on the eastern seaboard. Outfitted for rowing and sailing, they were used to move cargo between warehouses on shore and the trading ships.

The shape has been refined to accommodate the bead and cove planking . The boat may be sailed with the addition of a centreboard and sprit sail. The building notes for this project are presented on line – each purchaser receives a password allowing access to the detailed construction notes on the Canadian Canoes website.

© Drawn by Steve Killing
Steve Killing Yacht Design Inc.

Kits and Materials in the UK and Europe

Fyne Boat Kits offer plans and complete kits for the Bear Mountain Boats range, for shipping throughout the UK and Europe.

The kits include the plans, instructions, mould forms and all the materials: wood strips, wood glue, epoxy, fibreglass fabric, ash stems, gunwales, thwarts, yokes and seats. We also provide all these items separately for builders working from plans.

We manufacture our kits to the highest standard using European-grown Paulownia for the planking strips. Uniquely, the strips in our Bear Mountain Boats kits have not only a bead-and-cove profile but also a pre-cut finger joint at each end, making the neat joining of strips even easier for builders at home.

Fyne Boat Kits
www.fyneboatkits.co.uk
info@fyneboatkits.co.uk
+44 (0)1539 567 148

Why Paulownia?

Paulownia is a fast-growing tree which has been cultivated for optimal growing in the European climate. The trees are managed, harvested and processed locally so the supply chain is very short, making it ecologically sound and sustainable. Paulownia has a density of around 280kg/m³, so a bundle of 12m strips weighs approx 350g, which is 100g less than their Western Red Cedar counterparts.

Finger-Jointed Strips

Our finger-jointed strips can be joined to full length on the bench or in-place on the boat. It is quick and easy to join the strips neatly because we have machined this technical joint for you. These jointed strips keep delivery costs down compared to shipping full-length strips and they allow you to make economical use of your strips on a boat of any length.

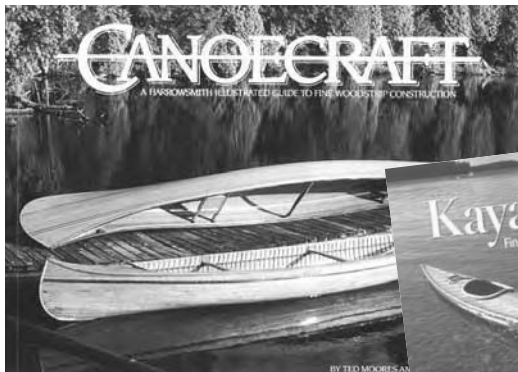

**WE WROTE THE BOOKS THAT
GUARANTEE PROFESSIONAL RESULTS**

CanoeCraft by *Ted Moores*

CanoeCraft is the standard textbook on woodstrip epoxy canoe construction. Completely revised and expanded in 2000 and includes 5 new designs and updated information and photographs. Published by Firefly Books.

KayakCraft by *Ted Moores*

Building a professional quality, elegant woodstrip kayak is now possible for the casual builder thanks to Ted Moores comprehensive book that gives the 'What', 'How' and 'Whys' in his usual clear language and precise illustrations. Published by Woodenboat Publications.



Bear Mountain

♣ B O A T S ♣

P.O.Box 191
Peterborough, Ontario, Canada K9J 6Y8

email: info@bearmountainboats.com
www.bearmountainboats.com

fyne boat kits

KITS, PLANS AND MATERIALS IN THE UK AND EUROPE

www.fyneboatkits.co.uk

info@fyneboatkits.co.uk

+44 (0)1539 567 148

Copyright Bear Mountain Boat Shop Inc. 2008.